

UNCLASSIFIED

<b>AD NUMBER</b>
ADB217749
<b>NEW LIMITATION CHANGE</b>
<b>TO</b> Approved for public release, distribution unlimited
<b>FROM</b> Distribution: DTIC users only.
<b>AUTHORITY</b>
NRL ltr. code 7600, 28 Sep 98

THIS PAGE IS UNCLASSIFIED



# DISCLAIMER NOTICE

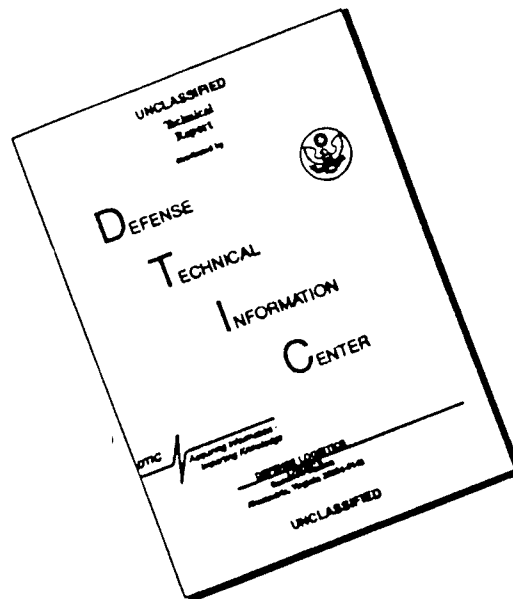

THIS DOCUMENT IS BEST QUALITY AVAILABLE. THE COPY FURNISHED TO DTIC CONTAINED A SIGNIFICANT NUMBER OF PAGES WHICH DO NOT REPRODUCE LEGIBLY.

ABSTRACT

Electronic technique is described for extending the upper limit of counting rates with Geiger-Mueller counters from the usual maximum of about 2500 counts per second to roughly 100,000 counts per second. A theory is proposed to explain the counting process at these high rates and the observed dependence of resolving power on counting rate.

The contents of the report include details of the design of a double pulse generator working down to separations of about 0.3 microseconds, and a scaling circuit capable of resolving about 1 megacycle per second of periodic pulses. The latter unit may have application to other experiments, for example, time measurement in ballistics problems.



Accession For	
NTIS CRA&I	<input type="checkbox"/>
DTIC TAB	<input type="checkbox"/>
Unannounced	<input checked="" type="checkbox"/>
Justification	
By	
Distribution /	
Availability Codes	
Dist	Avail and/or Special
12	

## TABLE OF CONTENTS

	Page
Abstract.....	b
Introduction.....	1
Theoretical Discussion.....	2
Experimental.....	4
Discussion of Data.....	6
Discussion of Results.....	8
	Plate
Basic Geiger Counter Circuit.....	1
Pulse Shapes for Various Resistors and the Stever Envelope.....	2
Pulse Shapes for Various Operating Potentials.....	3
Simple Amplifier and Slow Scaler.....	4
Tube Current vs. Operating Potential with $10^6$ Ohms Resistance...	5
Double Pulse Generator.....	6
One Megacycle Scale Unit.....	7
Block Diagram for Fast Counting.....	8
Counting Rate vs. Radiation Intensity for Various Operating Potentials.....	9
Charge per Pulse vs. Counting Rate for Two Operating Potentials.	10

## INTRODUCTION

Authorization. BuShips Project Order 384/46.

In the past, most experiments with Geiger counters, e.g. cosmic ray measurements, involved counting rates of the order of 10 counts per second or less. At rates as high as 200 to 300 counts per second the response of a self quenching counter is generally a linear function of the incident radiation intensity. Specifically, a counting system which has a resolving power of 2500 counts per second fails to resolve 10 per cent of the true number of pulses at a counting rate of 250 counts per second. Data taken at these rates can be readily corrected according to probability law, and the true intensity of radiation obtained. According to generally accepted views 5000 counts per second is roughly the upper limit on counting rates obtainable from a Geiger counter.

Recent applications of the Geiger counter for the measurement of high radiation intensities, however, required the development of higher resolving power counting systems. For example, in X-ray powder diffraction measurements using a Geiger counter spectrometer, the intensities of diffraction lines run as high as 2500 counts per second, thus making it desirable to have a counting system capable of resolving of the order of 25,000 counts per second in order to preserve a high degree of linearity.

The work described below demonstrated that such an improvement in resolving power of a Geiger counting system could be obtained for rates up to 10,000 counts per second, i.e., up to 10,000 counts per second the system behaved as if the resolving power was 25,000 counts per second. It was further shown that random rates as high as 100,000 counts per second were obtainable, and a theory of counter action was proposed to explain these results. Details are given below of the construction of amplifier, scaling circuits, and testing methods, for counting at these high speeds.

## THEORETICAL DISCUSSION

In Plate 1, the fundamental circuit of a Geiger counter is shown. The counter consists of a gas filled tube having a negatively charged cathode and a positive wire anode connected in series with the resistor R. In the present work we are concerned only with the fast, or vapor quenched, type of counter. The negative pulses which appear on the wire may be detected by capacitative coupling to either an oscilloscope or pulse amplification system.

The operating high voltage of the counter is of the order of 1000 volts, and is determined by placing a source of radiation near the tube and slowly raising its potential until "counts" are observed. The voltage is then set at about 100 volts above this threshold.

The counter pulses are corona discharges triggered by the formation of ion pairs in the gas volume. These ion pairs may be produced by X-ray or  $\gamma$ -ray photoelectric absorption, Compton scattering, or pair production. The momentary discharge can produce as many as  $10^{10}$  electrons, or a current flow of several microamperes. Most of the multiplication in the discharge is realized within a distance comparable to the wire diameter, in which region the electrons accelerated toward the anode obtain enough kinetic energy in one mean free path to produce impact ionization. The development of the Townsend avalanche requires only a fraction of a microsecond. In the course of this Townsend discharge formation, ultra-violet light of sufficient hardness to create ion pairs in other parts of the tube is generated by recombination. The discharge is not confined to one region of the anode, but spreads down the length of the wire leaving a heavy positive ion sheath surrounding it. During the initial rush of electrons to the wire the positive ions remain almost stationary. Their presence in the vicinity of the anode reduces the field to the point where corona can no longer be maintained, and according to generally accepted theories this space charge is entirely responsible for quenching the discharge. The positive ions by virtue of their low mobility require about 500  $\mu$ s to reach the cathode. The most abrupt change in anode voltage occurs in the initial rush of electrons to the wire. Thereafter the course of the voltage across the tube is a function of the migration of the positive ions and the recovery time of the fundamental circuit. The organic vapor plays an important role in the formation of the discharge and in suppressing secondary emission at the cathode and consequent reignition of the discharge, but a discussion of the details of these processes is not essential to the interpretation of the results of the present experiments.

At a certain critical separation of charge, i.e., after the ion sheath has traveled a given distance from the wire, the field recovers sufficiently so that corona discharges are again possible and the counting system can record pulses. Stever<sup>1</sup> concluded that a well defined deadtime exists corresponding to the spreading of the ion sheath to the critical distance, and that no counts are detectable in this interval. His experiment, designed to illustrate this "deadtime", consisted of connecting the Geiger counter directly to a triggered sweep oscilloscope and observing the pulse pattern. Following the initiation of the sweep by a pulse from the counter no pulses were observed for

a distance on the sweep of the order of 200  $\mu$ s. At the end of this interval he observed the foot of an envelope of pulses whose height increased with increasing distance from the triggering pulse. This is illustrated in Plate 2, figs. A and B. Stever deduced from these results that the maximum possible counting rate is the reciprocal of the deadtime, or about 5000 counts per second in the above case. The experiments described below show that the above conclusion is valid only for small pulse amplification. While it is certainly true that the field in the counter is reduced by space charge below the minimum corona field, it is still capable of supporting gas amplification of the order of  $10^5$  to  $10^7$ . It should be possible with sufficient amplification in the external circuit to detect the small pulses that are formed in the reduced field about the wire following a corona pulse. This would have the effect of improving the linearity at low rates, i.e., increasing the resolving power, and at the same time would considerably raise the upper limit of fast counting. These smaller pulses are localized discharges that may require amplification as high as 1000 times for detection.

A simple experiment which cannot be accounted for in terms of the "deadtime" theory consists of attempting to realize the ultimate counting rate as predicted by the "deadtime" theory ( $1/T_d \sim 5000$ ) by irradiating a Geiger tube connected to a low gain amplifying system with very high  $\gamma$ -ray intensities. Instead of a value  $\sim 5000$  counts per second being approached, a value of the order of 3000 counts per second is attained, and thereafter the counting rate rather sharply decreases to zero as the intensity of radiation is further increased. The "deadtime" theory would explain the decrease in counting rate as due to the decrease in pulse size to the point where it finally becomes less than the discrimination level of the amplifier. Under these conditions the counter tube is supposed to be producing about 5000 equally spaced pulses per second. This interpretation, however, is irreconcilable with the fact that as one increases the intensity of radiation, the tube current increases steadily and approaches an asymptotic limit. In a typical tube this current may be 10  $\mu$ A. If this current is to be accounted for by only 5000 counts per second, a charge of  $20 \times 10^{-10}$  coulombs per pulse is required. This is a value about twice that observed for the same tube at low counting rates and is clearly impossible. All indications support the fact that the small corona pulses, such as are found at the foot of the Stever envelope are less than 1/100 of full value, i.e., the value of the charge per pulse at low counting rates. In fact one would require a number of pulses equal to the observed maximum current divided by the charge per pulse (of reduced size), or  $10^{-5}/10^{-9}/100 = 10^6$  per second to properly explain such a tube current consistent with a reasonable pulse size.

Under the conditions of intense irradiation and fixed amplifier gain a constant resolving power is not to be expected, for the space charge conditions vary with radiation intensity. At high counting rates space charge introduces two effects: first, the discharge pulse changes from the corona to the localized type, and second, the effective sensitive volume is reduced. Detection of the pulses by a counting system with a given amplitude and frequency response must certainly result in producing a counting rate which depends on radiation intensity in a complex manner.



## EXPERIMENTAL

It is first instructive to ascertain pulse shape or sharpness as a function of the resistor  $R$  and high voltage. Experimental results are shown in Plates 2 and 3. It should be observed that in all cases the rise time is under a microsecond (though exaggerated in A and B of Plate 2), but that the decay time is a direct function of  $R$ . In D of Plate 2 it can be seen that the pulse duration can be made as small as  $1 \mu s$ . If pulse width were the only factor limiting resolution one would expect maximum counting rates of the order of  $10^6$  per second.

Plate 2 also illustrates Stever's experiment, the envelope being indicated by the dotted line. This experiment was performed here with the modification of inserting a variable gain amplifier between the Geiger counter, and the oscilloscope. For amplifications under 100, Stever's pattern was reproduced, but as the gain and radiation intensity was increased the deadtime interval filled with pulses. This observation verified the hypothesis that impact ionization pulses could be observed provided sufficient gain were used to amplify them. The amplifier employed in this experiment was of the video type with a maximum gain of 1000 and variable gain control. Plate 4 shows a much simpler type of amplifier which is adequate for high speed counting. The preliminary experiments to actually record the high rates observed on the oscilloscope were performed using the simple amplifier and conventional double triode scale units having a resolving time of  $12 \mu s$ .

Assuming that pulses formed in reduced fields were detected by the high gain amplifier it should have been possible to detect pulses at sub-threshold operating voltages, at low counting rates. It was found that pulses were detected as much as 100 volts below threshold, assuming threshold corresponds to pulses of the order of one volt amplitude. Plate 5 shows the tube current as a function of high voltage for a particular counter under constant intensity of irradiation.  $T_1$  and  $T_2$  mark respectively the threshold for low and high gain amplifying systems. In this case  $T_2$  was 80 volts below  $T_1$ .

It was soon recognized that though the Geiger counter showed no signs of saturation, the counting system could not be made to respond faster than 45,000 counts per second. To obtain still higher counting rates, it was necessary to improve the resolving power of the scale units. This was apparent since a scaler of resolving power 80,000 counts per second would pass only 40,000 counts per second of an 80,000 count per second random input; and if the random input rate were increased to 100,000 counts per second, the number detected would increase to only 44,500 counts per second. From these results it was evident that a scaler of resolving power at least equal to  $10^6$  counts per second would be required to achieve random counting rates of the order of  $10^5$  per second.

For the purpose of testing various scale circuit models a fast double pulse generator<sup>2</sup> was designed capable of testing resolving times less than  $1 \mu s$ . The circuit diagram of this generator is shown in Plate 6. It produced double pulses whose repetition rate (i.e., pair rate), amplitude, width and separation could be conveniently controlled. The separation could be made

as small as  $1/3 \mu s$ , or the equivalent of 3 megacycles per second.

With the aid of this test unit the scaler shown in Plate 7 was readily constructed with a resolving power of about 1 megacycle per second. Three such units were constructed and used in series ahead of the slower speed double triode scale 1024. At a later time an improved unit capable of resolving 2 megacycles per second was designed, but not actually used in the work here described. The method of testing was simply to apply the pulse pairs to the scaler at a given repetition rate and wide separation. If the scale unit resolved these double pulses, the output pulse rate was just equal to the repetition rate since the pairs were scaled to unity. As the pulse separation was reduced, a point was finally reached where the pairs affected the scaler as though they were a single pulse. When this happened the output of the unit suddenly fell to one half the repetition rate. The pulse separation at this point was equal to the scaler resolving time and could be measured on a calibrated oscilloscope sweep.

It was necessary to insert at least three of the 1 megacycle per second scale units between the amplifier and slow scalers to obtain a counting rate of  $10^3$  per second. As the fast units were added their effect on the observed counting rate became successively less profound. For instance the counting rate in thousands per second obtained by applying the ten slow scale stages first directly to the amplifier and then in succession to the various fast stages gave in one case the series:

45, 78, 93, 102

A block diagram of the arrangement of our apparatus for recording these high rates is shown in Plate 8. Three fundamental requirements should be noted: (1) extreme differentiation in the input circuit, (2) high gain, high frequency amplification ( $10^3$ - $10^4$ ), and (3) high resolving power scaling units. For purposes of insuring proper electronic action of these circuits, it was required that low counting rate values be independent of amplifier gain. As a further check, the output from the amplifier was observed again on a triggered sweep oscilloscope and found to give a random pattern. That is, no ringing or periodicity was observed.

## DISCUSSION OF DATA

The fundamental data of counting rate as a function of radiation intensity for different counter high voltages is shown in Plate 9. The results were obtained by applying the addition method with two radium sources. In the interesting high counting rate region for the curves at normal operating potentials, i.e. A, B, and C, it will be observed that they are straight lines on a log-log plot, and obey an equation of the type:

$$R = R_0 I^{3/5}$$

where "R" is the counting rate at intensity "I" and "R<sub>0</sub>" the counting rate at unit intensity. For curve "A" this equation becomes:

$$R = 7 \times 10^3 I^{3/5} \quad \text{subject to } I > 2$$

This power law follows from the fact that the slope of these lines is 3/5. It is further of note that in this same region the resolving power, R<sub>max</sub>, is not constant, but directly proportional to the instantaneous rate, R. For these curves it follows a law:

$$R_m = \frac{5}{2} R$$

This is readily deduced from the fact that the fraction of counts lost at any time, R/R<sub>m</sub>, is equal to the difference between a 45° slope and the actual slope. That is:

$$\frac{R}{R_m} = \frac{2}{5} \quad \text{or} \quad R_m = \frac{5}{2} R$$

In general, if "k" is the slope of a counting rate vs. radiation intensity curve on a log-log plot:

$$R_m = \frac{R}{1-k}$$

Perfect linearity is also represented by a straight line on the above plot, but must slope at tan<sup>-1</sup> 1, i.e., at 45° (since then R = R<sub>0</sub> I). A constant resolving power curve, however, is not a straight line on this coordinate scheme. The shapes of the curves indicate constant resolving power only below 10,000 counts per second (the foot of the straight line portion of the curve). From curve "A" at 10,000 counts per second:

$$R_m = \frac{5}{2} 10^3 = 25 \times 10^3/\text{sec.}$$

At 5000 counts per second the slope increases to 4/5, but again:

$$R_m = \frac{1}{1-4/5} 5 \times 10^3 = 25 \times 10^3/\text{sec.}$$

To a close approximation this saturation figure was maintained down to the very low rates, not indicated in Plate 9. Above 10,000 counts per second the resolving power advanced ahead of the counting rate in the manner outlined above. At any counting rate it appeared that 40 per cent of the counts were lost (since  $R/R_m = 2/5 = .4$  or 40%).

The charge per pulse as a function of counting rate is also shown in Plate 10. Several points are noteworthy. For low counting rates the charge per pulse was large and approximately constant. As the rate increased this value gradually diminished and the curve eventually assumed a negative 45° slope. This is to say the charge per pulse varied as:

$$Q = \frac{K}{R}$$

which for the straight portion of curve "A" was:

$$Q = \frac{8.3 \times 10^{-6}}{R} \quad \text{subject to } R > 20,000/\text{sec.}$$

Actually, at the very high rates (> 90,000 counts per second) the tube current began to fall off a little. Undoubtedly under these conditions large pulses are no longer present.

## DISCUSSION OF RESULTS

The use of a high gain amplification counting system made possible the operation of a counter tube in a combination of the Geiger counting and proportional counting regions. The net effect was to improve the resolving power and consequently the linearity at low rates by a factor of 10. It was further possible to obtain counting rates better than 100,000 per second. Greater amplifier gain coupled with increased scaling circuit resolving power (both within limits attainable by modern electronic techniques) should make it feasible to count at rates of the order of 1 megacycle per second.

REFERENCES

- (1) H. G. Stever, Phys. Rev. 61, 38 (1942)
- (2) H. Lifschutz, N.R.L. Manual, July 12, 1940 Communications Security  
Section, Radio Division

BASIC GEIGER COUNTER CIRCUIT

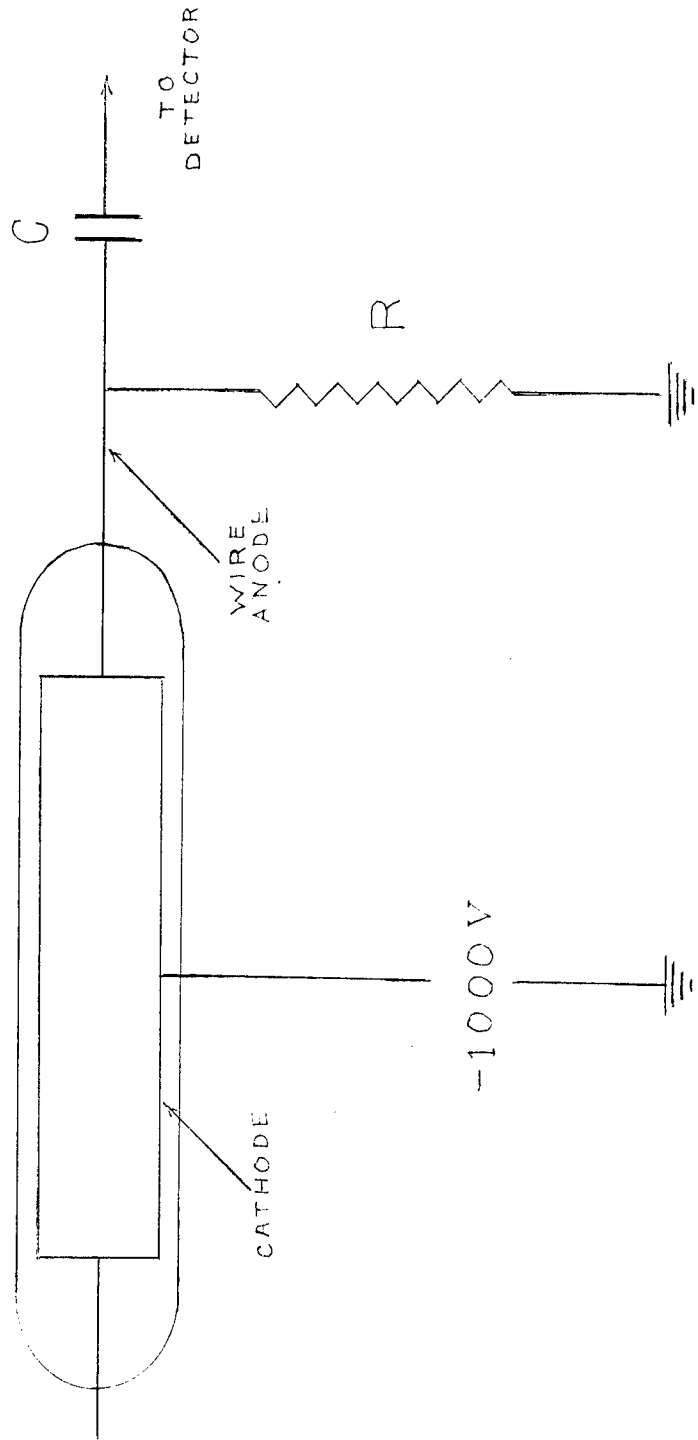

H-2758

PLATE I

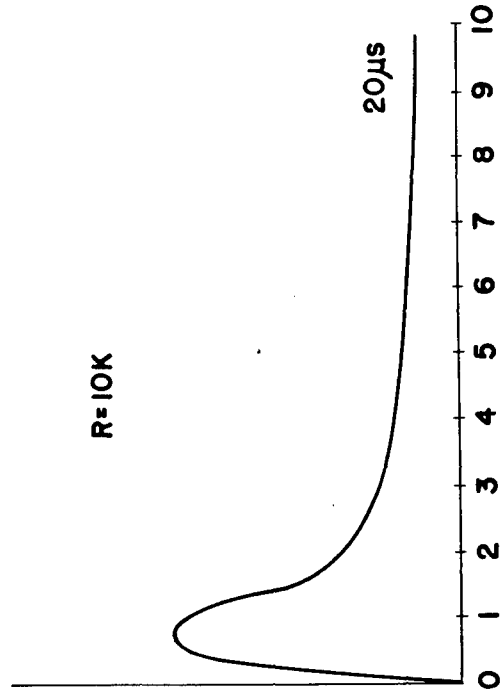
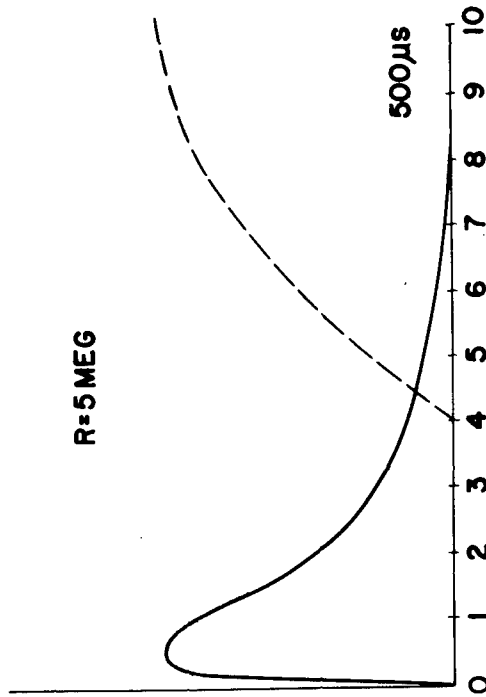
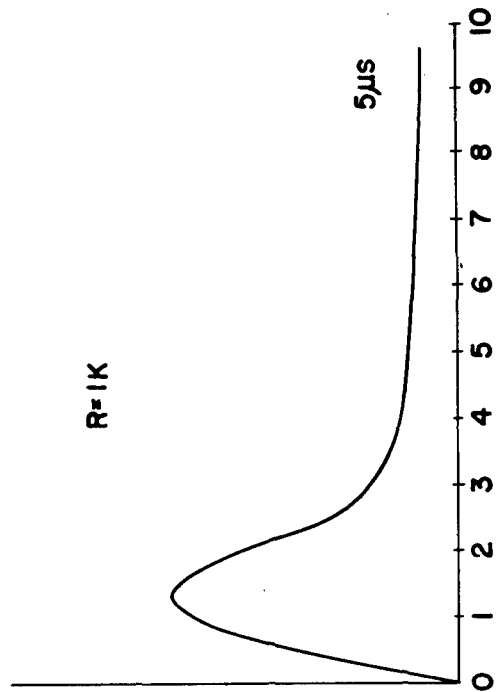
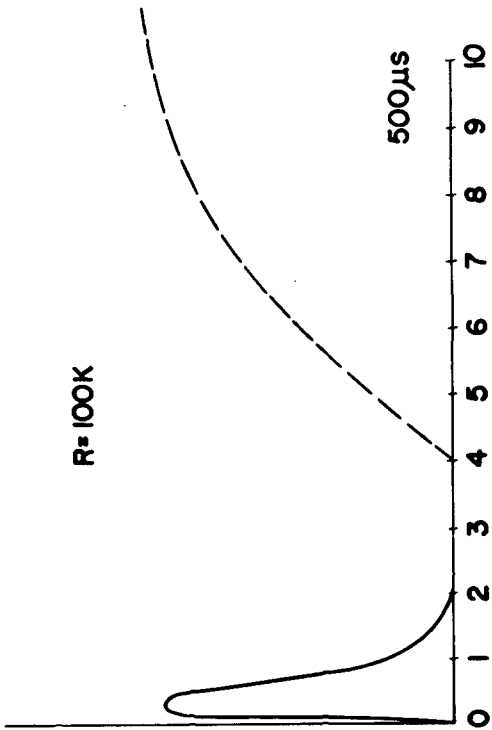

H- 2758

PLATE 2



H-2758

R=70K  
V=670V

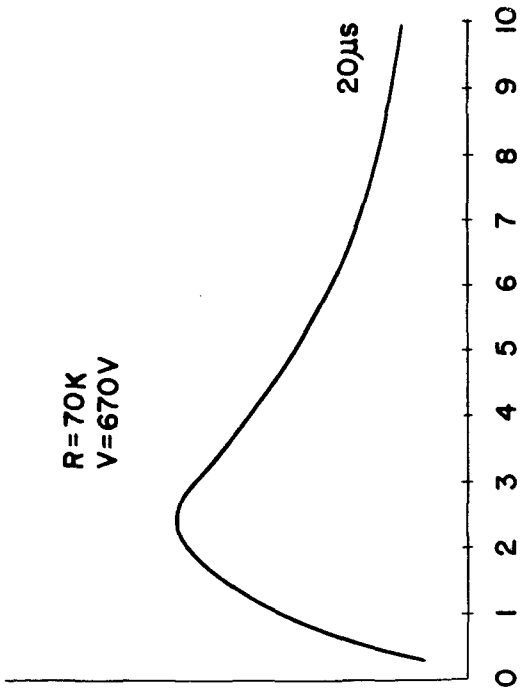

R=70K  
V=720V

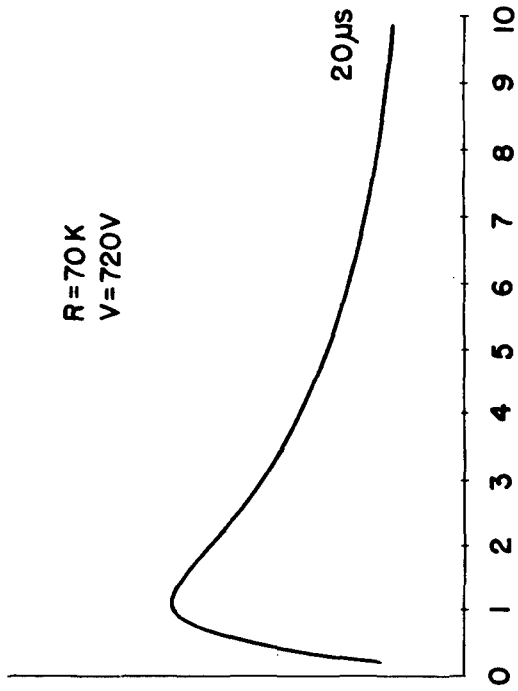
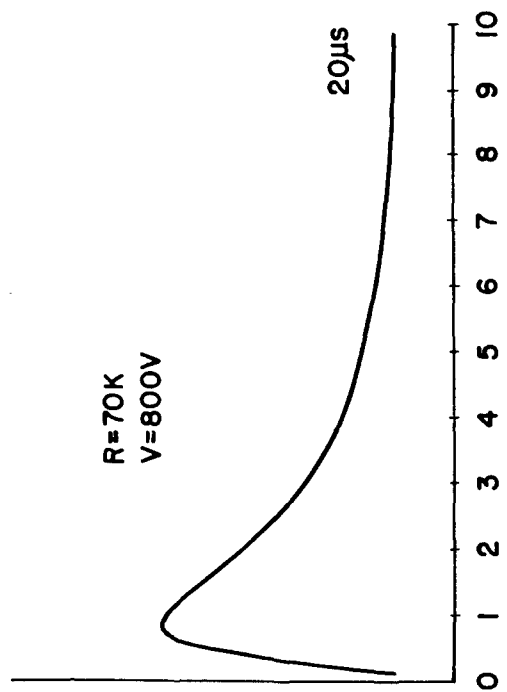
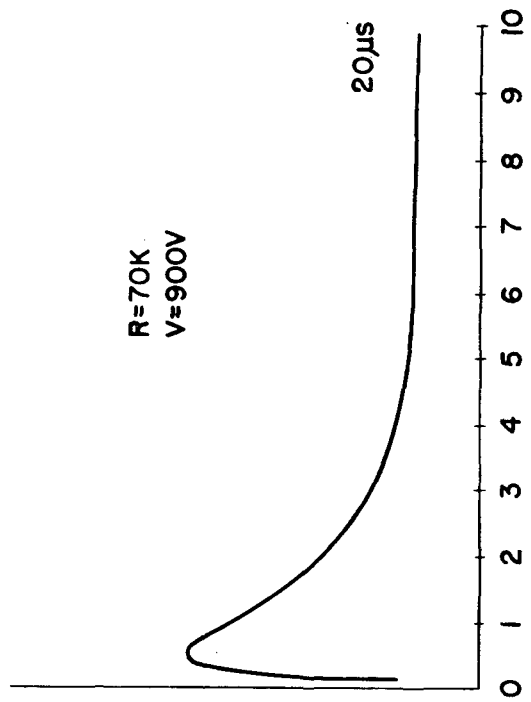

PLATE 3

R=70K  
V=800V



R=70K  
V=900V



H-2758

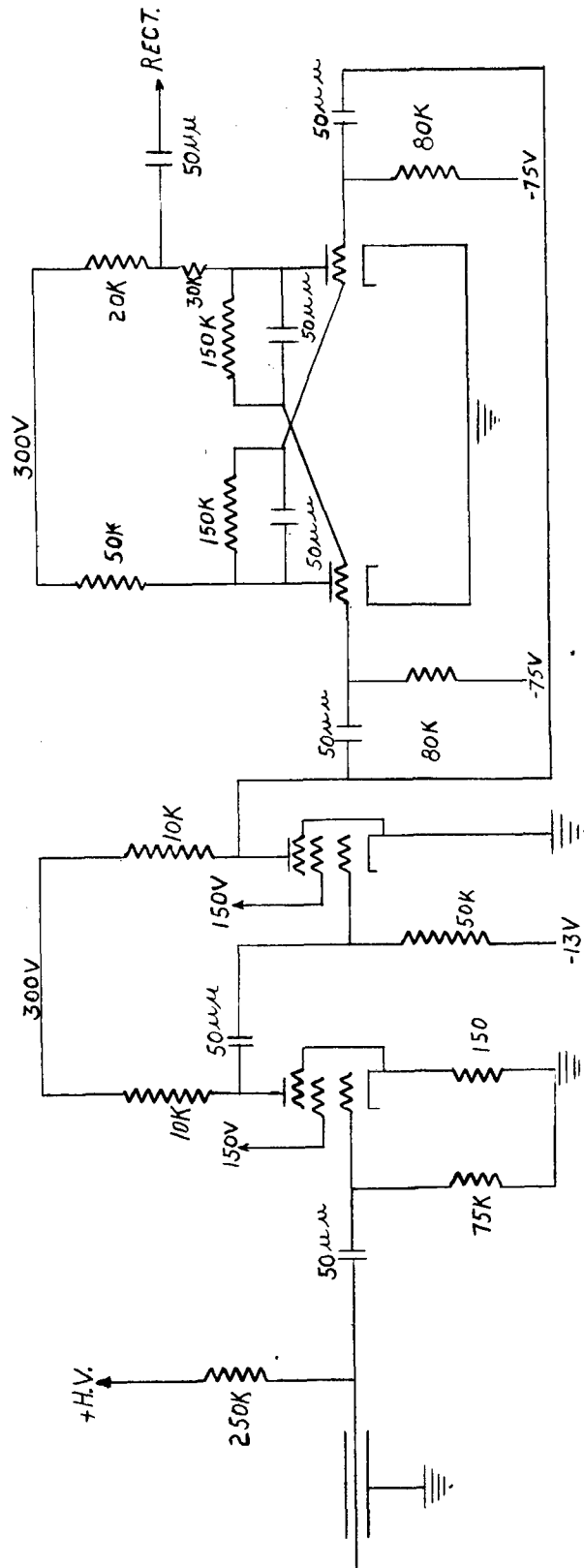

6SL7

6AG7

6AG7

AMPLIFIER AND SLOW SCALER

PLATE 4

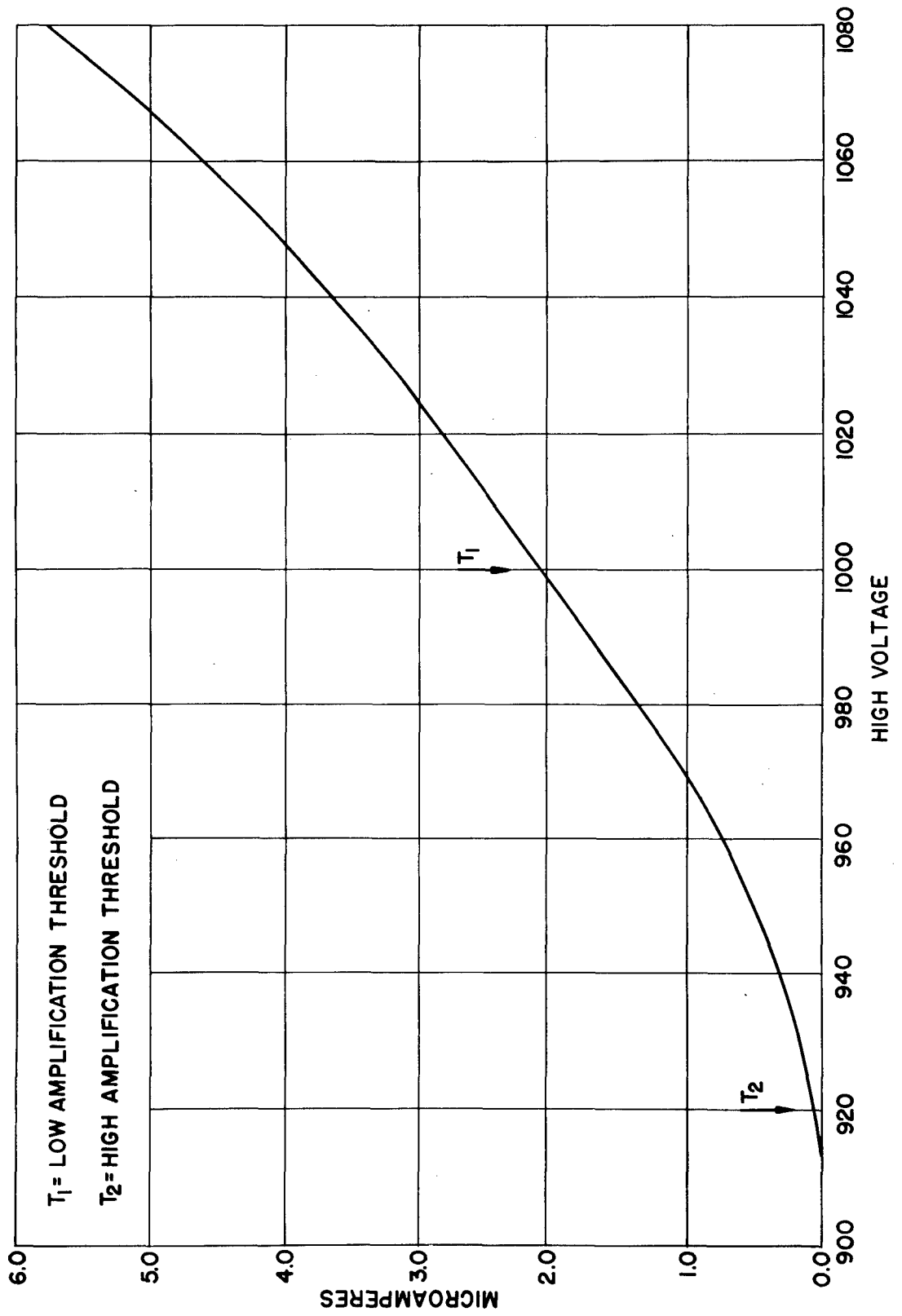

H-2758

PLATE 5



SCALER  
RESOLVING TIME: 1 $\mu$ S

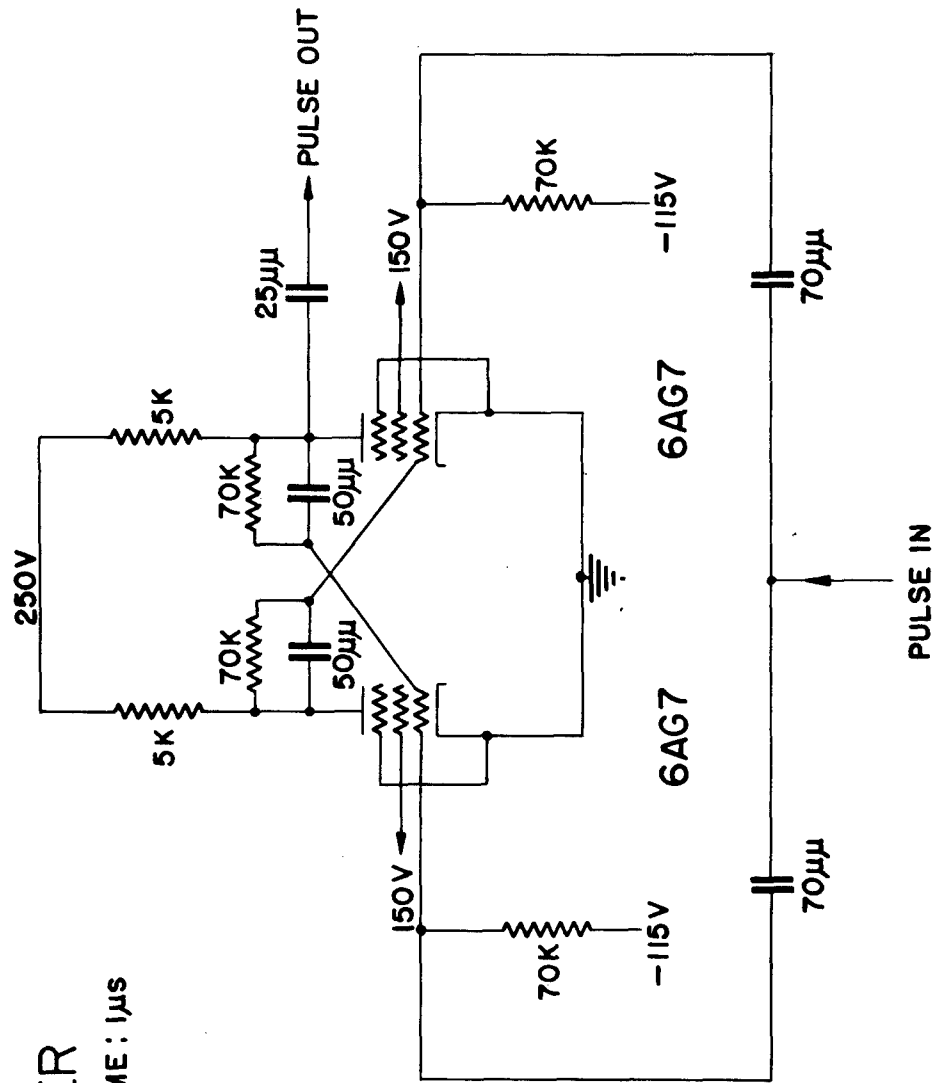

# BLOCK DIAGRAM FOR FAST COUNTING

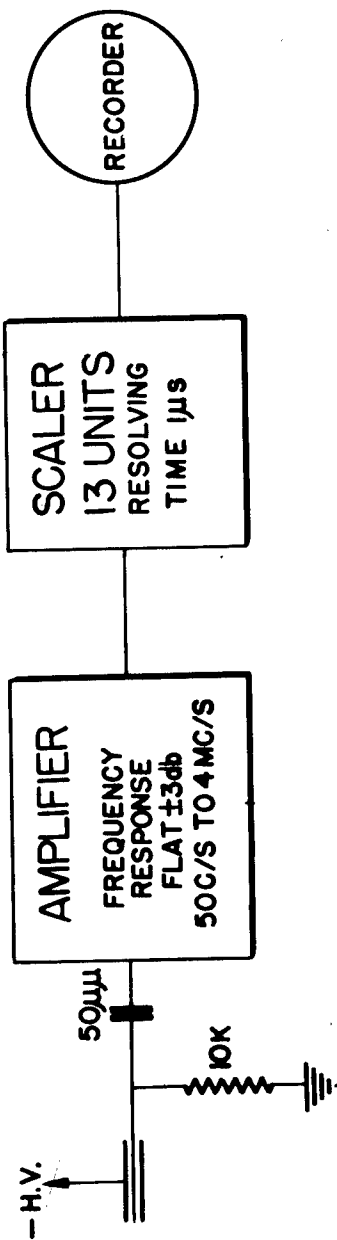

H-2758

PLATE 8

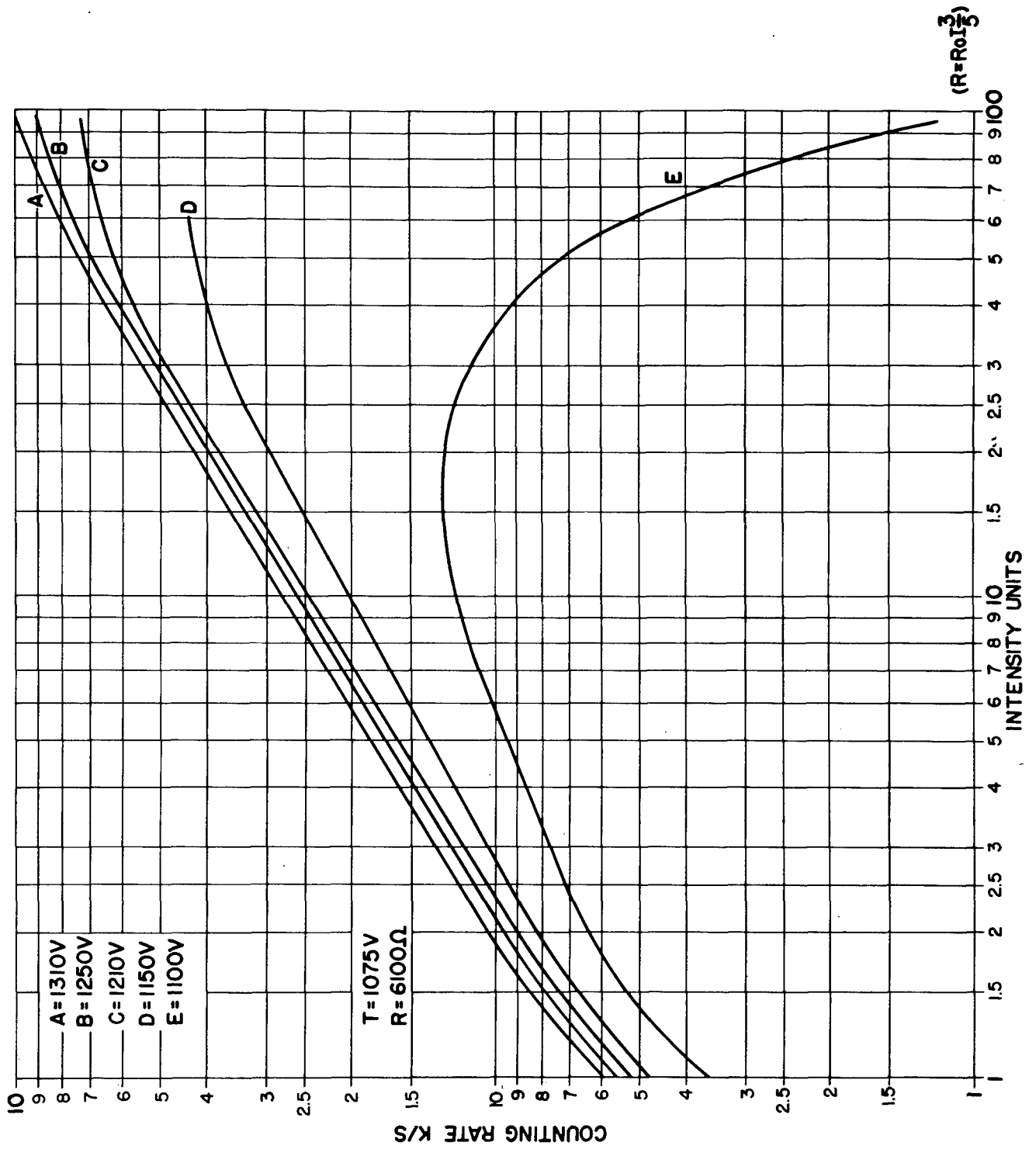

H-2758

PLATE 9

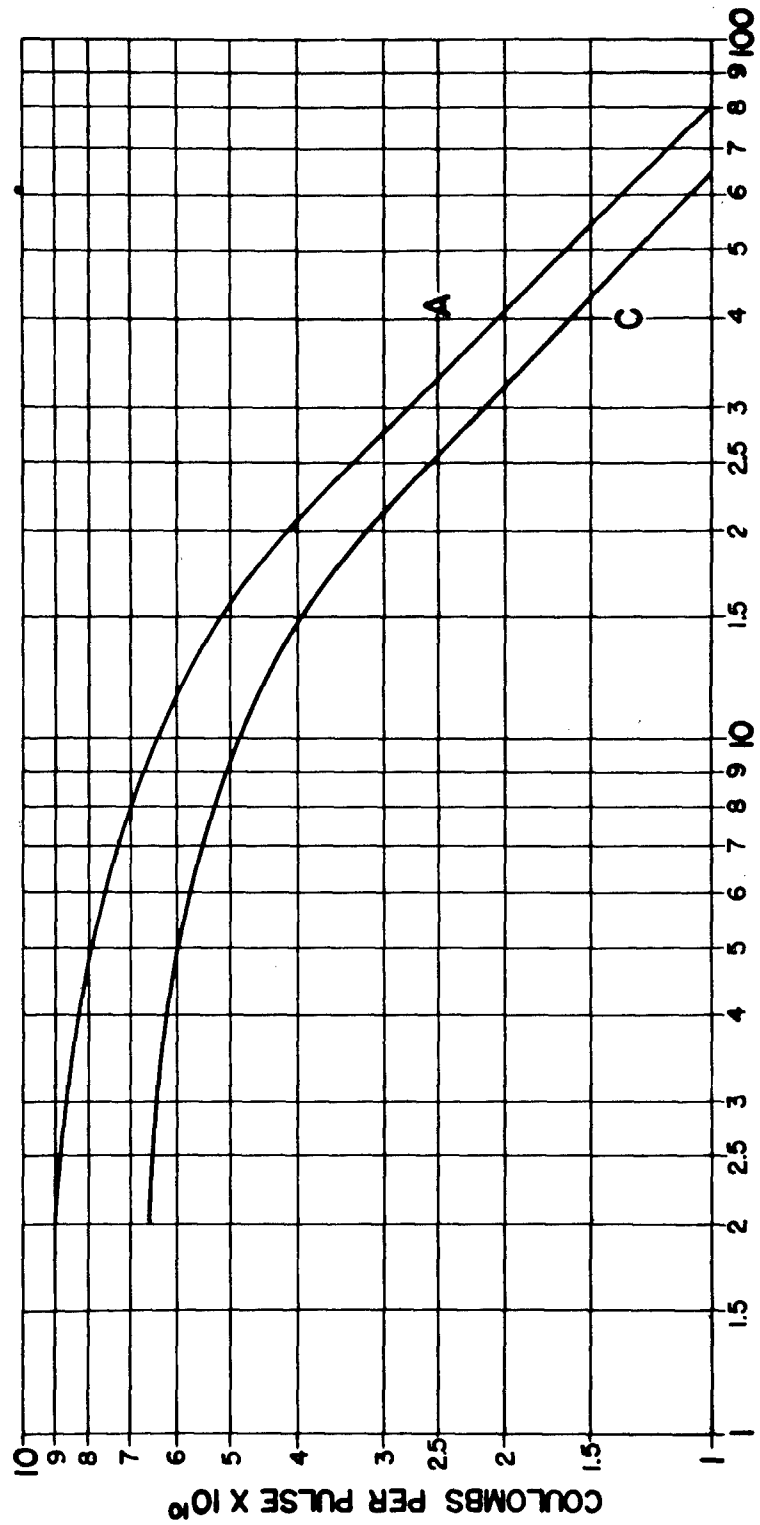

T=1075V  
R=6100Ω

A=1310V  
C=1210V



DISTRIBUTION:

BuShips	(5)
BuOrd	(5)
BuAer	(2)
BuMed	(2)
National Naval Medical Reserve Center	(1)
Naval Proving Grounds	(1)
Office of the Chief of Ordnance	(1)
Commanding Officer Signal Corps Engineering Laboratory Bradley Beach, New Jersey Attn: Director, Squire Signal Lab. (Components and Materials Branch)	(1)
Navy Liaison Officer, Ft. Monmouth, New Jersey Attn: Capt. Williams	(2)

# memorandum

Ser 059  
DATE: 28 Sep 98

REPLY TO  
ATTN OF: Code 7600

SUBJECT: REVIEW OF "GEIGER COUNTER" REPORTS

TO: Codes 5227  
1221.1 *On 9/30/98*

1. I have reviewed five unclassified NRL reports entitled, "Geiger Counter Technique (M-  
\*1800)," "Geiger Counter Technique for High Counting Rates (H-2758)," "Geiger Counter  
Tubes (AD3196664)," "Low Voltage Self-Quenching Geiger Counters (N-3189)," and  
("Sensitive Geiger-Muller Counters for Detection of Gamma Rays (M-1886).")

*NO AD #*

2. I recommend that the "limited distribution" statements be removed from each report and  
be replaced with "unlimited distribution." Thank you.



HERBERT GURSKY  
Superintendent  
Space Science Division

\* AD-B811200  
AD-B 217 749V  
AD-B218681V  
AD-B 196 664